



CROFT



Product Code: 1772

Product Name: Cylinder Pull - Euro Profile | 31mm centres Back to Back Fixing

Description: Installed through the door with a fixing bolt, the Back-to-back Cylinder Pull sits on both sides of the door, allowing users to easily pull the door open or closed.

The curved base creates a comfortable grip and ensures the pull stands slightly away from the door surface, making it easy to grasp. Ideal for entrance doors, office doors, and commercial access points, this back-to-back design ensures usability from either side of the door.

Shown here in our Antique Nickel finish.

Product Information

Supplied with M5 x 60mm machine screws

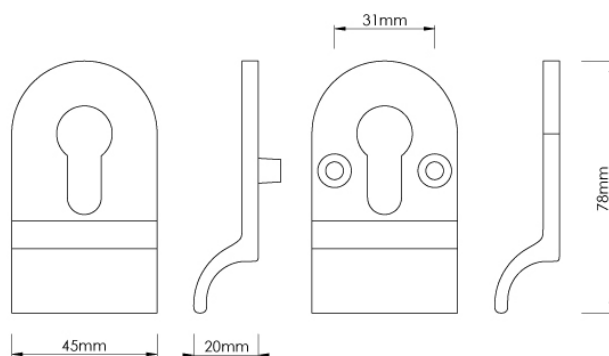

Available in all Croft finishes excluding DORB, IBMA, IBUL, MBK, ORB, RBMA, TB,